



WORLD WIDE PRODUCTS

Ensuring Operational Excellence

Tandem Sling Seating System

Product Catalogue



Company Profile

World Wide Products is a reputed company with more than three decades of experience to its credit in the manufacture, supply and export of office furniture parts and components.

The production, treatment and processing of every component incorporates most modern technology using state-of-the-art machinery, sourced from the very best in the world. The manufacturing facility is located in a sprawling 75,000 sqft. complex at Mandi, Gobindgarh in Punjab. There is a dedicated work force of more than 250 skilled and semi skilled workers to handle the operations of this magnitude.

Being pioneers in office chair component industry, World Wide is all about optimizing value out of each rupee spent by our esteemed clientele. Our products are developed on the concept of simplicity, smart design and high precision workmanship. As a result each component remains functional and retains their inherent qualities, even after prolonged and vigorous usage. Furthermore, each and every World Wide product / component combines traditional values with modern blueprint that ultimately translates into comfort in a well-designed chair.

Pan India Sales & Marketing Network

Our sales and marketing operations span across the length and breadth of India. We serve our customers through a well established dealer and distributor network which is active in twenty eight states in India.

Employee Skill Upgrade Program

At World Wide we recognize the importance of lifelong learning and the need for continual education and skill upgrade. We conduct regular training programs to help our employees to better appreciate their true value and reward their skills. This exercise boosts their moral, improves their efficiency and productivity.

Introducing Tandem Sling Seating

Tandem sling seating is attractive and sturdy modular seating system specially developed for large public waiting areas at airports, railway stations and hospitals. It is designed to withstand exceptional levels of wear and tear. The system provides a generous seating and back rest surfaces for comfort and relaxation during long waiting hours. This simple modular system enables the units to be added together as required and at will to achieve any desired formation or configuration. Around the world people find this system very comfortable and inviting place to wait. The airport terminal operators appreciate its space-saving attributes, flexibility, durability and easy maintenance.



Vision

We pledge to:

- Ensure excellence by incorporating world class technologies in our products.
- Provide a working environment that is conducive to the professional growth
- Care for all our employees in sickness and in health.
- Maintain hygienic working conditions in our factory.
- Preserve and protect our environment.

Certifications & Accreditations

BIFMA



UQSR



World Wide Products proudly supports the Make In India initiative



Works at Mandi-Gobindgarh, Punjab

Continuing Three Decades of Excellence

The parent company World Wide Products with presence in 28 states remain pioneers in office component industry. It manufactures world class office chair parts and components. The company has in-house design & development facility which makes it effortlessly possible to produce full scale prototypes of various office furniture based on customer's design and engineering requirement for sepecific product line.



Secondary Design Modification

We are open to carry out modifications to a limited extent in design wherever possible to meet the specific requirement of particular location.

This simple modular system enables the units to be added together as required and at will to achieve any desired formation or configuration. Around the world, people find this system very comfortable and inviting place to wait. The airport terminal operators appreciate its space-saving attributes, flexibility, durability and easy maintenance.

Our Strengths

We have the necessary prerequisites, to optimize production values and maintain consistent quality at all times. Some of them are:

- Installed capacity of 1.20 Lakh units per annum.
- Fully automatic production line.
- A modern material testing Laboratory.
- All products conform to BIFMA Standards of the USA.



Managing Director - Mr. Jaspal Sachdeva

Managing Director's Message

Dear Friends

I take this opportunity to thank all our valued customers, whose continued patronage and confidence in our products have always inspired us to improve our quality and extend the best of services; it has also encouraged us to provide best value for their money.

Let me assure all of you that World Wide Products will always remain committed to high standards in all its ventures. We will always focus on addressing the needs of our customers by offering efficient and reliable products, which will always be at par with best in the world.

Over the years, I have felt the need to explore new avenues within the ambit of the *Seating Systems Industry*. After years of deliberations and introspection, we have zeroed in on, 'Tandem Sling Seating System' which is the internationally preferred choice for large public waiting areas at the airports, railway stations and hospitals.

It gives me great pleasure to inform that we have set up a fully automated manufacturing facility - at Mandi, Gobindgarh in Punjab - with state-of-the-art machinery. This effort of ours is in line with the, 'Make in India' drive which underlines the commercial objectives of the nation.

On this occasion, I seek the support of our valued customers, along with the cooperation and dedication of our employees. I also wish to thank our well-wishers and associates who have contributed to the growth of World Wide Products over the years.

In the end let me reiterate that without your endless support the journey so far would not have been possible.

Thank You



**Superior
Metal Chairs**

8



**Superior
Aluminium Chairs**

14



**Classic
Metal Chairs**

18



**Premium
Metal Chairs**

23



Superior
Metal Chairs

Superior - Metal Visitor Chairs

Application Area :

Airport terminals, Hospitals, Railway stations and other large public waiting areas.

Material Specification :

Chair-Seat : High quality cold rolled sheet is perforated, pressed and welded to form the shape. The surface is then cleaned with acid to remove rust and electrostatically coated with epoxy powder and then cured under heat to allow it to form a "skin". Thickness - 1.2mm.

Decorative Edge : High quality metal is bent to form the shape and then the surface is polished to perfection.

Arm / Leg : High quality Mild Steel tube/ sheet is welded to form the shape. The surface is then cleaned with acid to remove rust and powder coated. Thickness - 1.2mm.

Cross bar : High quality cold rolled sheet is pressed and welded to form the shape and the surface is then cleaned with acid to remove rust and powder coated. Thickness - 2mm.

Customization :

Seat : Choice of single seater to five seater.

Colors : Choice of colors; Chrome, Silver Grey, Blue, Cherry and Black.

Arms : Can be customized to give different colors and finishes; powdercoating/ chrome plating.

Product Code: There is a provision of providing additional arms in between two seats where the product code becomes "AA" as suffix with its regular code e.g. 5002 becomes 5002 AA.

Legs : Can be customized to give different colors and finishes; powdercoating/ chrome plating.

Dimensions :

Width : 710 mm

Height : 775mm

Length : 635mm per seat approx.

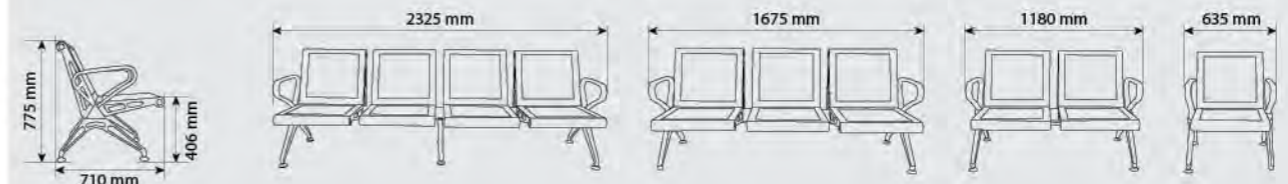

[We undertake special projects and develop products as per customers' specifications and designs]

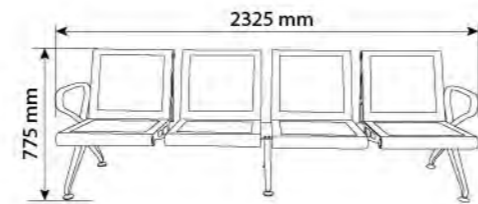
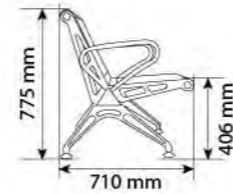

WVC - 5004

Superior Metal Visitor Chair - Steel Seat, Steel Arms & Legs

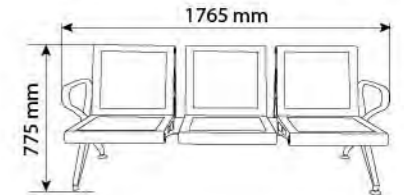
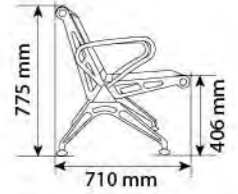

WVC - 5013

Superior Metal Visitor Chair - Steel Seat, Chrome Arms & Legs

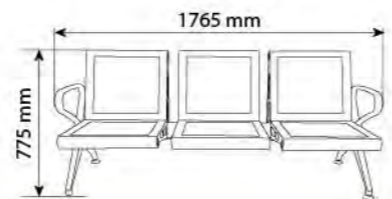
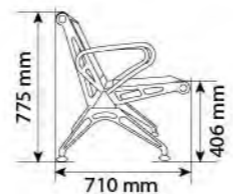

WVC - 5003

Superior Metal Visitor Chair - Steel Seat, Steel Arms & Legs

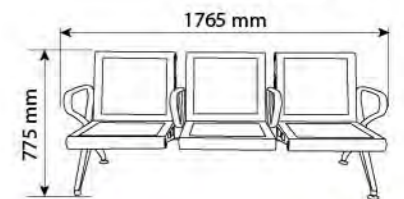
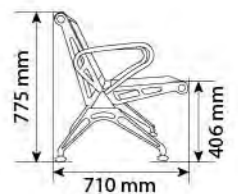

WVC - 5003 AA*

Superior Metal Visitor Chair
*AA in product code stands for Additional Arms

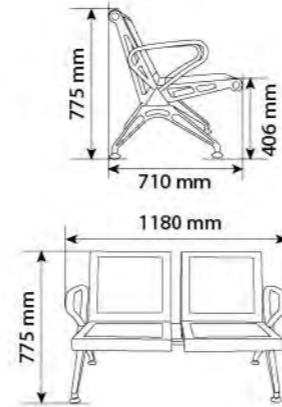

WVC - 5002

Superior Metal Visitor Chair - Steel Seat, Steel Arms & Legs



Cherry



Blue

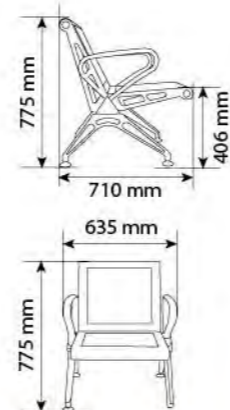

WVC - 5001

Superior Metal Visitor Chair - Steel Seat, Steel Arms & Legs



Silver Grey



Black

Colors Available





Superior
Aluminium Chairs

Superior - Aluminium Visitor Chairs

Application Area :

Airport terminals, Hospitals, Railway stations and other large public waiting areas.

Material Specification :

Chair-Seat : High quality cold rolled sheet is perforated, pressed and welded to form the shape. The surface is then cleaned with acid to remove rust and electrostatically coated with epoxy powder and then cured under heat to allow it to form a "skin". Thickness - 1.2mm.

Decorative Edge : High quality metal is bent to form the shape and then the surface is polished to perfection.

Arm / Leg : Aluminium alloy is pressure die-cast to form the shape and then surface is polished

Cross bar : High quality cold rolled sheet is pressed and welded to form the shape and the surface is then cleaned with acid to remove rust and powder coated. Thickness - 2mm.

Customization :

Seat : Choice of single seater to five seater.

Color : Choice of colors; Chrome, Silver Grey, Blue, Cherry and Black.

Arms : Can be customized to give different colors.

Product Code: There is a provision of providing additional arms in between two seats where the product code becomes "AA" as suffix with its regular code e.g. 5022 becomes 5022 AA.

Legs : Can be customized to give different colors.

Dimensions :

Width : 710 mm

Height : 775mm

Length : 635mm per seat approx.

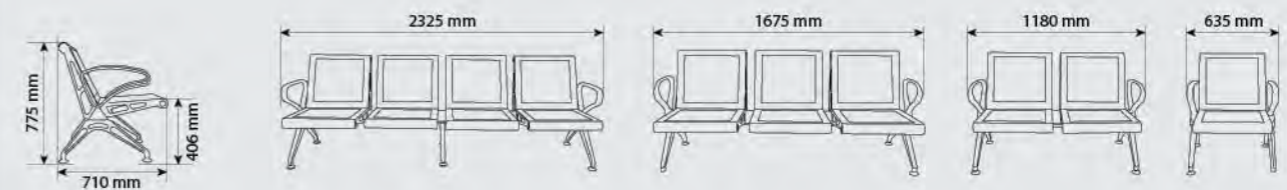

[We undertake special projects and develop products as per customers' specifications and designs]



WVC - 5023

Superior Aluminium Chair - Steel Seat, Aluminium Arms & Legs

- Easy to clean
- Maintenance free
- Anti-microbial properties
- Environmental friendly
- Internationally preferred public seating solution

Product Code	
WVC - 5021	Single Seater
WVC - 5022	Two Seater
WVC - 5023	Three Seater
WVC - 5024	Four Seater



Due For Launch in 2018

PU cushion panels for seat and back can be used in our tandem sling seating system.

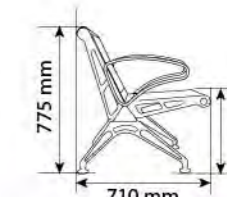
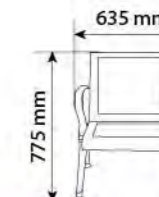
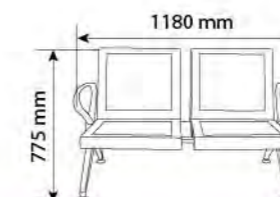
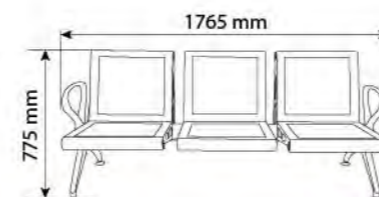
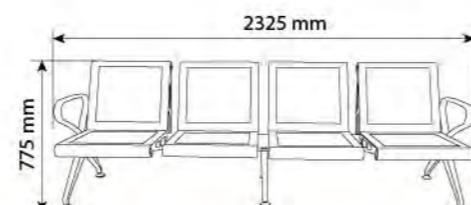
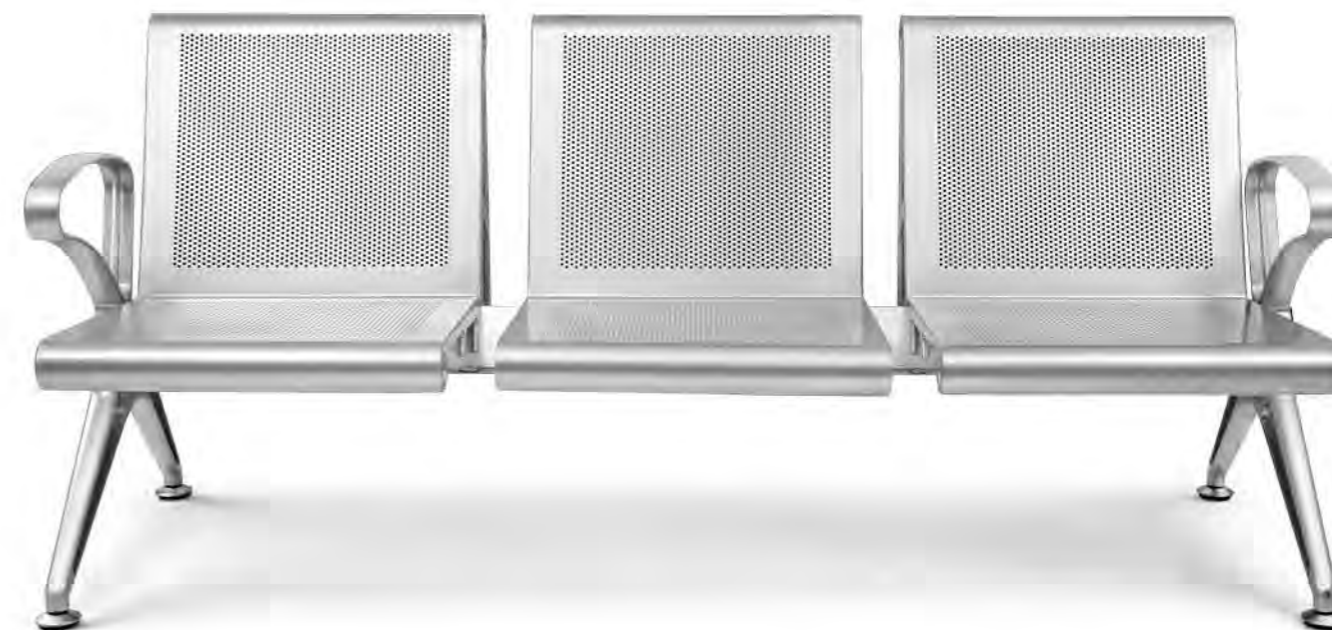



Classic
Metal Chairs

Classic - Metal Visitor Chairs

Application Area :

Airport terminals, Hospitals, Railway stations and other large public waiting areas.

Material Specification :

Chair-Seat : High quality cold rolled sheet is perforated, pressed and welded to form the shape. The surface is then cleaned with acid to remove rust and electrostatically coated with epoxy powder and then cured under heat to allow it to form a "skin". *Thickness - 1.2mm*

Decorative Edge : High quality metal is bent to form the shape. The surface is then polished and chrome plated.

Arm / Leg : High quality Mild Steel sheet is pressed and welded to form the shape. The surface is then polished and chrome plated. *Thickness - 1.2mm*

Cross bar : High quality cold rolled sheet is pressed and welded to form the shape and the surface is then cleaned with acid to remove rust and powder coated. *Thickness - 2mm*

Customization :

Seat : Choice of single seater to four seater.

Color : Choice of colors; Chrome, Silver Grey, Blue, Cherry and black .

Dimensions :

Width : 690 mm

Height : 790mm

Length : 610mm per seat approx.

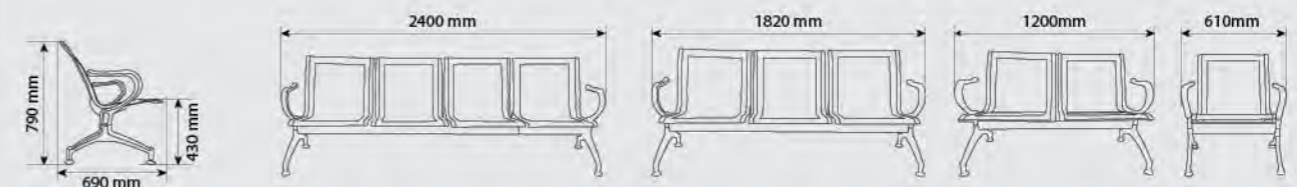

[We undertake special projects and develop products as per customers' specifications and designs]

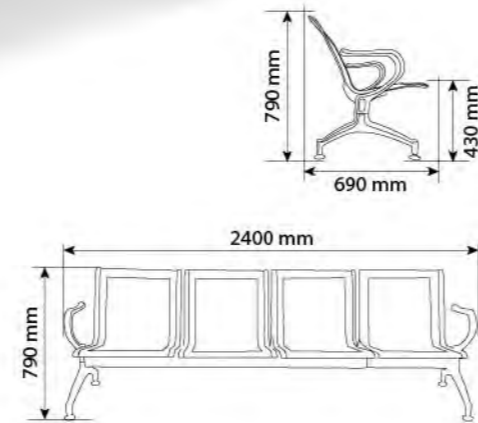

WVC - 5054

Classic Metal Chair - Steel Seat, Chrome Arms & Legs

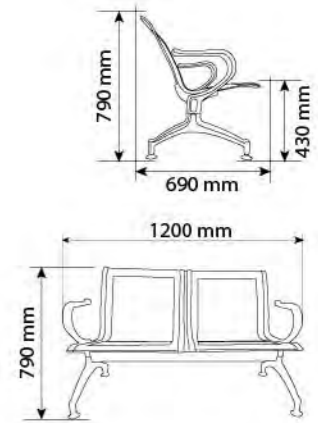

WVC - 5052

Classic Metal Chair - Steel Seat, Chrome Arms & Legs

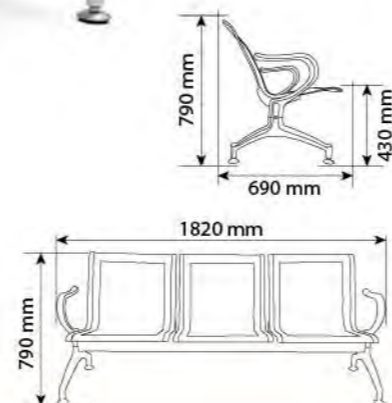

WVC - 5053

Classic Metal Chair - Steel Seat, Chrome Arms & Legs

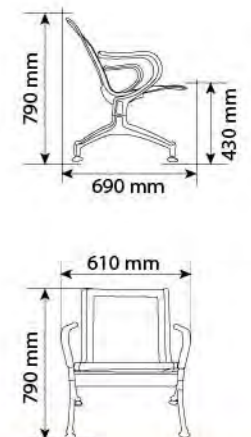

WVC - 5051

Classic Metal Chair - Steel Seat, Chrome Arms & Legs



WVC - 5063
Premium Metal Chair - Steel Seat, Chrome Arms & Legs



WVC - 5061
Premium Metal Chair - Steel Seat, Chrome Arms & Legs

Product Code	
WVC - 5061	Single Seater
WVC - 5062	Two Seater
WVC - 5063	Three Seater
WVC - 5064	Four Seater

Colors Available



Cherry



Blue



Silver Grey



Black

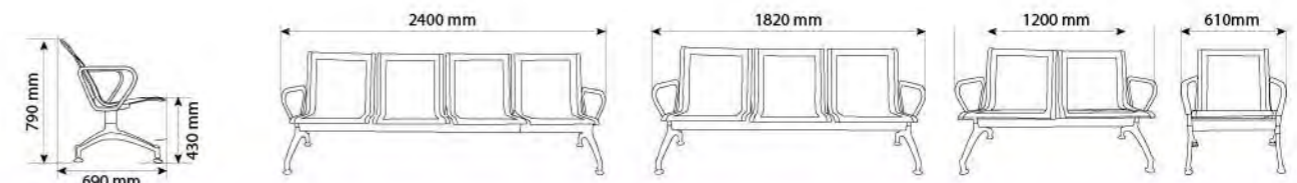



Superior



Components In Three Seater Kit



Step 1: Turn the seats up side down and place the centre beam on it



Step 2: Fasten the beam with allen keys



Step 3: Attach the adjusters to the legs



Step 4: Place the long side of the leg in front



Step 5: Attach the legs to centre beam



Step 6: Attach the arms to centre beam



Step 7: Check carefully all the joints. The seat is ready

Classic / Premium

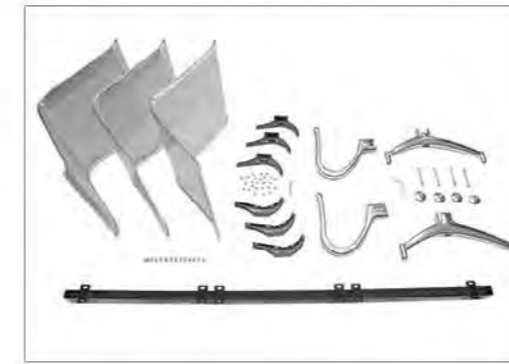

Components In Three Seater Kit



Step 1: Turn the seats up side down and fasten the clamps with allen keys on each seat



Step 2: Fasten the beam with allen keys



Step 3: Attach the adjusters to the legs



Step 4: Put the long screws in leg so that it come up to be fasten with the arm



Step 5: Attach the legs to centre beam



Step 6: Attach the arms to the legs and fasten the screws that put inside in step 4



Step 7: Check carefully all the joints. The seat is ready



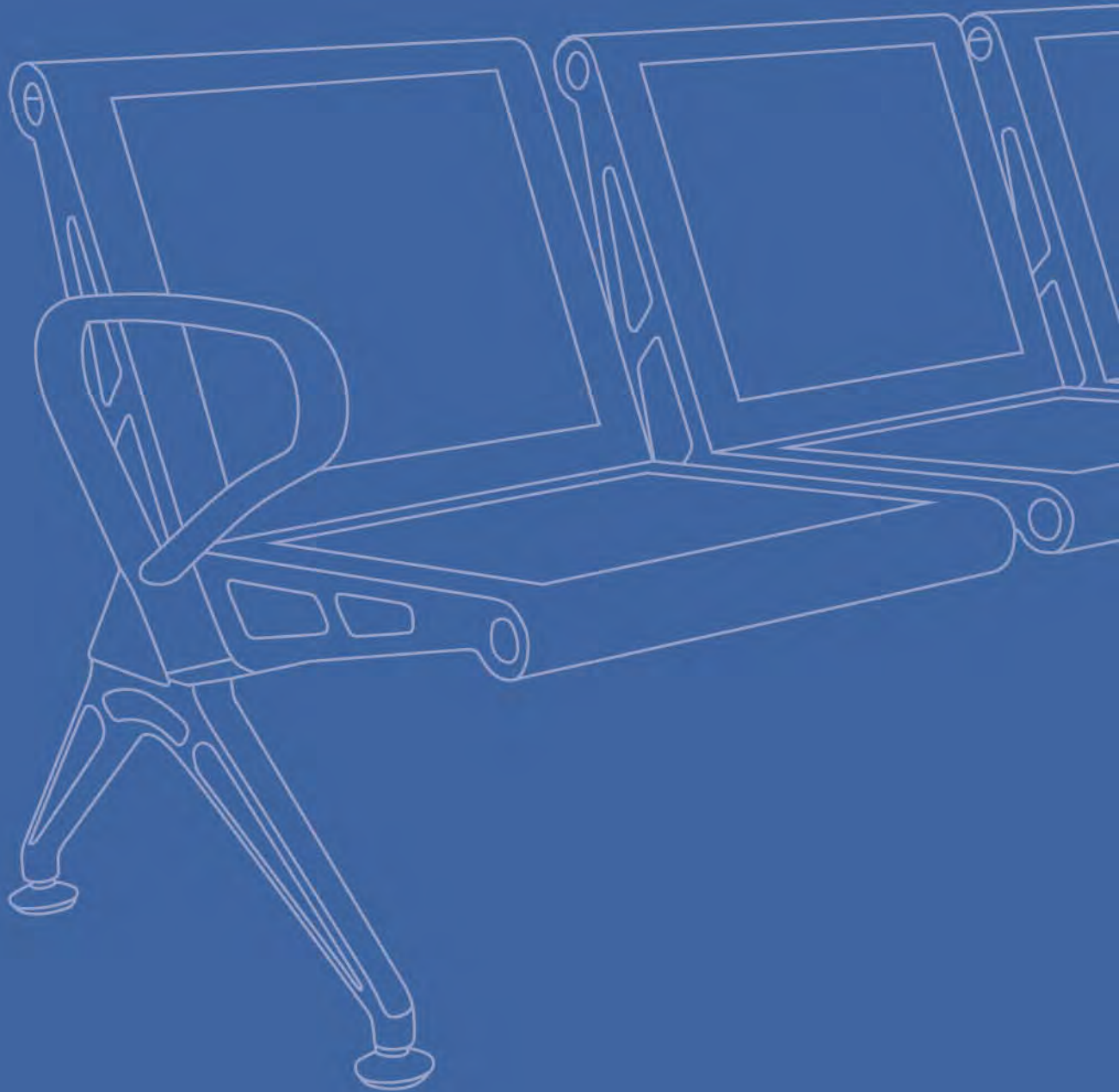

WORLD WIDE
Products Pvt. Ltd.

Head Office/ Showroom:

7/1, 2nd Floor, Furniture Block, W. H. S. Kirti Nagar New Delhi- 110015. INDIA

Ph: 91-11-25988215, 25989300 Cell: 91-93505 49805

Fax: 91-11-25984878

Email: info@worldwideproductsindia.com

Visit us at: www.worldwideproductsindia.com